

Motorized M3 AX7200 Rotary-Style Gasket Cutter Operating Instructions

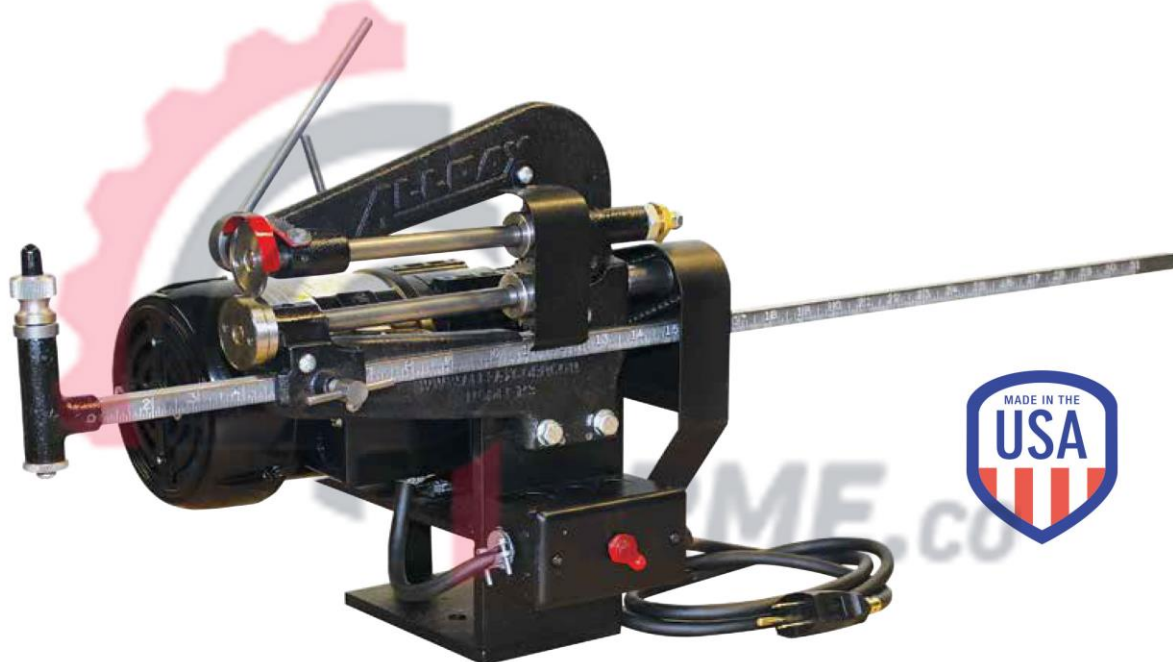

تامین و تجهیز ابزار دقیق آرمه

Armecompany.com

09125795160

ALLPAX®

GASKET CUTTER SYSTEMS

INTRODUCTION

Congratulations! You are the owner of the finest rotary-style gasket cutter in the world. Originally developed and patented in the 1930's, the Motorized M3 Rotary-Style Gasket Cutter is ideal for the custom fabrication of ring and flange gaskets. Thousands are in use everyday in a wide range of industries including petrochemical plants, shipbuilding yards, power plants, breweries, pulp and paper plants, refrigerated facilities, and oil refineries. Easy to operate and virtually maintenance-free, the Motorized M3 Rotary-Style Gasket Cutter will cut perfect gaskets and provide trouble-free operation for years to come.

MOTORIZED M3 SPECIFICATIONS

Weight:	41 pounds
Configuration:	Recommended for fixed or mobile operation.
Mounting:	Bench mount
Throat:	7"
Cutting Diameters:	2"ID to 62"OD with optional long scale bar (included)
Gasket Width:	1/4" to 7"
Gasket Thickness (Max):	1/4" (See table for maximum thickness by material)
Cutter Set Installed:	Cutter set (top & bottom) for non-metallic gaskets
Type of Motor:	Daytona Model 6Z820

MOTORIZED M3

Maximum Recommended Material Thickness (Inches)

GASKET MATERIAL	THICKNESS
Asbestos	0.125
Cardboard (Flat)	0.250
Cloth Insert	0.188
Cork	0.188
Fiber	0.188
Kevlar	0.010
Rubber	0.188
Teflon	0.125



ASSEMBLY

Carefully unpack the unit. Remove the protective tape around the top cutting disc being careful of the razor sharp edge. The Motorized M3 comes fully assembled and pre-adjusted at the factory.

MOUNTING THE UNIT



(Figure 1) Motorized M3 mounts to any workbench with four 3/8" bolts (not included).

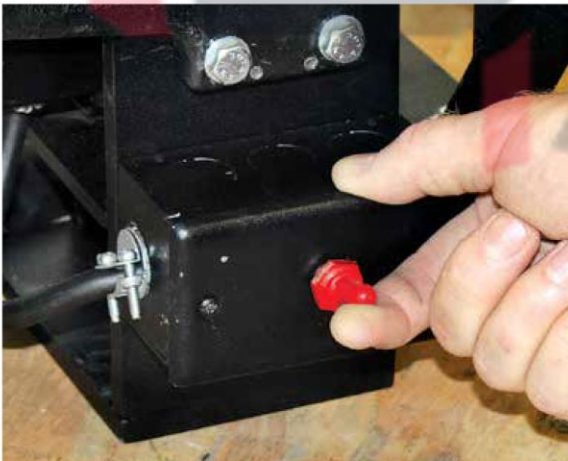

(Figure 2) The Motorized M3 uses a momentary switch, meaning the switch must be held in the on position while operating.

OPERATING THE UNIT

Motorized M3 is equipped with a set of cutting discs for non-metallic gasket materials. With the exception of very thin metallic materials, cutting metallic gaskets is generally not recommended.

Select the sheet gasket material to be cut. Measure the material and cut into a rough square making sure that the shortest side measures larger than the outside diameter (OD) of the gasket to be cut. Trim the corners if necessary.

Punch 11/32" guide hole (#13 punch) in the approximate center of the trimmed gasket material.

NOTE: *Punching the exact diameter guide hole ensures that the gasket material stays centered and that the cutter tracks properly.*

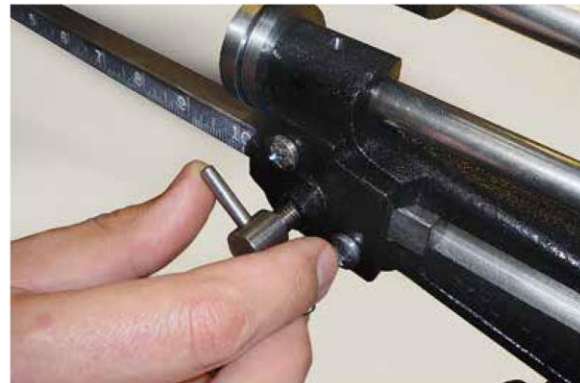

(Figure 3) Loosen the scale bar tee screw and slide the scale bar to the desired OD setting. Hand tighten the tee screw.

NOTE: *Markings on the scale bar designate radius, not diameter.*



(Figure 4) Disengage the top cutting disc by rotating the cutter disc lever counter-clockwise.

OPERATING THE UNIT



(Figure 5) Unscrew and remove the scale bar knurled nut from the scale bar assembly. Using the guide hole, position the gasket material onto the threaded scale bar spindle. Screw the knurled nut back onto the spindle to firmly secure the material. Hand tighten.



(Figure 6) To cut the OD, engage the top cutting disc by rotating the cutting disc lever clockwise. The top cutting disc should now penetrate the gasket material and is now in the proper position for cutting.

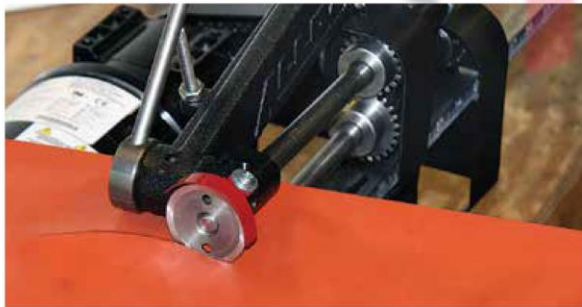

(Figure 7) Hold down momentary switch to engage motor. Simultaneously, with the other hand, maintain a constant downward pressure on the cutting disc lever. As the cutting discs rotate, the gasket material will be drawn towards the cutting discs initiating the cutting process. Continue pressing switch until the entire OD of the gasket material has been cut. Disengage the top cutting disc. Discard unwanted material.

NOTE: Cutting thick and/or tough materials may require more than one revolution through the unit. Flipping the material over and repeating the above process is often advantageous.



(Figure 8) To cut the inner diameter (ID), loosen the scale bar Tee screw, and slide the scale bar to the desired setting. Hand tighten the scale bar Tee screw. Engage the top cutting disc. Hold down momentary switch to engage motor, simultaneously maintaining downwards pressure on the cutting disc lever as before. Continue pressing switch until the entire ID of the gasket material has been cut. Disengage the top cutting disc and remove newly cut gasket. Unscrew and remove knurled nut from spindle. Discard unwanted material.

ARME.co

REPLACING THE CUTTING DISCS

The Motorized M3 incorporates a set of cutting discs that can be replaced as they wear. Both discs are held in place via threads.

NOTE: The top cutting disc incorporates a left-hand thread and the bottom disc incorporates a right-hand thread.



(Figure 9) To replace the top cutting disc, first remove the scale bar assembly. Disengage the top cutting disc. Insert the spanner wrench (included) into the two holes on the disc. Grip the spanner wrench firmly. Loosen the disc by turning spanner wrench. Loosening the thread may require a firm strike with a soft hammer or mallet. Screw a new cutting disc into place using the spanner wrench. Tighten by turning the spanner wrench clockwise. Use extreme caution, as cutting disc is very sharp.



(Figure 10) To replace the bottom cutting disc, first remove the scale bar assembly. Disengage the top cutting disc. Insert the spanner wrench into the two holes on the bottom disc. Grip the spanner wrench firmly. Loosen the disc by turning spanner wrench. Loosening the thread may require a firm strike with a soft hammer or mallet. Screw a new cutting disc into place using the spanner wrench. Tighten by turning the spanner wrench clockwise. Use extreme caution, as cutting disc is very sharp.

SHARPENING THE TOP CUTTING DISC

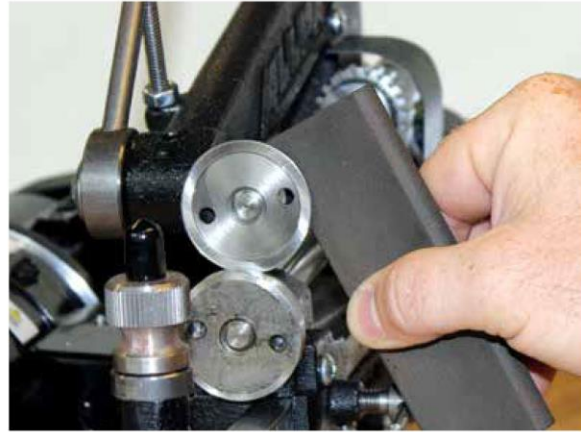

(Figure 11) Sharpen by holding a small, hand sharpening stone to bevel side of the cutting disc. Hold the stone to the flat face to remove rolled edges or burrs. Press and hold the momentary switch. Be careful of your fingers.

NOTE: The bottom cutting disc is not designed to be sharpened.

**TO SEE THE
MOTORIZED M3 IN ACTION
SCAN THE QR CODE BELOW**



CUTTER ADJUSTMENTS

The positions of the cutting discs are pre-set at the factory. However, over time, as cutting discs wear and/or are replaced, adjustments may need to be made to maintain proper operation.

Check the cutting discs to make sure that the cutting edges are sharp, have no nicks or dings, and are concentric. Replace if necessary. Ensure that the discs are tight on their respective shafts by tightening with the spanner wrench. To adjust the cutter refer to the **CUTTER ADJUSTMENT DIAGRAMS** on page 7.

Note: Proper cutter adjustment must proceed in the following order: Top Shaft Assembly End-Play, Clearance, Depth.

Removing Top Shaft Assembly End-Play

Disengage the top cutting disc (A) by rotating the cutting disc lever (H) counter-clockwise. Using 7/8" wrench, loosen jam nut (C). Preset thrust bearing (D) to a space of 3/16" with 7/8" wrench. Tighten the jam nut against thrust bearing housing (G).

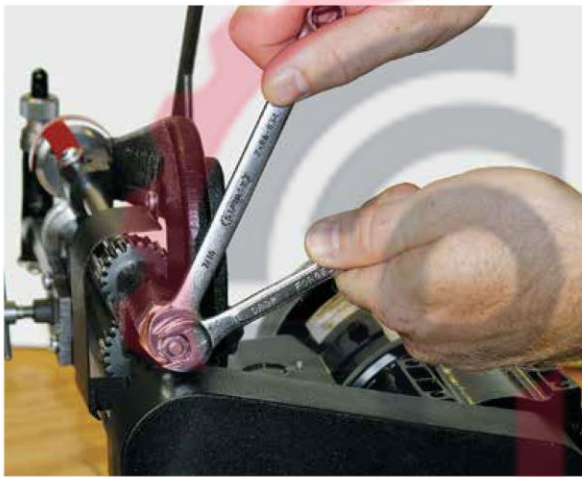

(Figure 12) Remove top shaft assembly end-play by unscrewing the outer hex-nut (F) with 7/16" wrench and adjusting the inner hex-nut (E) in, or out. Once end-play is removed (top shaft assembly will not slide back and forth), lock the inner hex-nut in position. Hold the inner hex-nut with a wrench and tighten the outer hex-nut snug against the inner hex-nut, being careful not to change the position of the inner hex-nut. Double check that end-play has been removed. Crank cutter handle to make sure the top shaft assembly has not been adjusted too tight that it rotates with just slight resistance.

Clearance Adjustment (x axis)

First, set the initial clearance between the bottom cutting disc (B) and top cutting disc (A). Loosen the jam nut until the thrust bearing rotates freely. Engage the top cutting disc by slowly rotating the cutting disc lever clockwise, making sure that the top cutting disc lines up with the slot adjacent to the bottom cutting disc. Adjust the thrust bearing in or out as necessary to ensure this alignment.



(Figure 13) The final clearance can now be set by gently tightening the thrust bearing until the side of the top cutting disc just contacts the side of the bottom cutting disc, then backing off slightly. Tighten the jam nut against thrust bearing housing.

Note: When making the clearance adjustment, make sure the outermost edge (diameter) of the top cutting disc does not interfere with the bottom cutting disc when engaging cutting disc lever, or damage will occur to the top cutting disc edge.

The correct clearance adjustment positions the discs close enough such that standard copy paper can be cut cleanly by the unit.

Depth Adjustment (y axis)



(Figure 14) The depth of cut is adjusted by screwing the depth adjustment screw (I) in, or out, until 1/32" depth of cut is achieved. Lock adjustment screw in place with locking nut using 7/16" wrench.

Note: The correct depth adjustment allows the top cutting disc to be fully lowered adjacent to the bottom cutter without mechanical interference.

Chain Adjustment & Alignment

Remove chain guard (1). Loosen four motor bolts to tighten and align chain (2). Slide motor to tighten chain. There should be no slack in the chain. Chain should be aligned evenly on both shafts (3).



CUTTER ADJUSTMENT DIAGRAMS

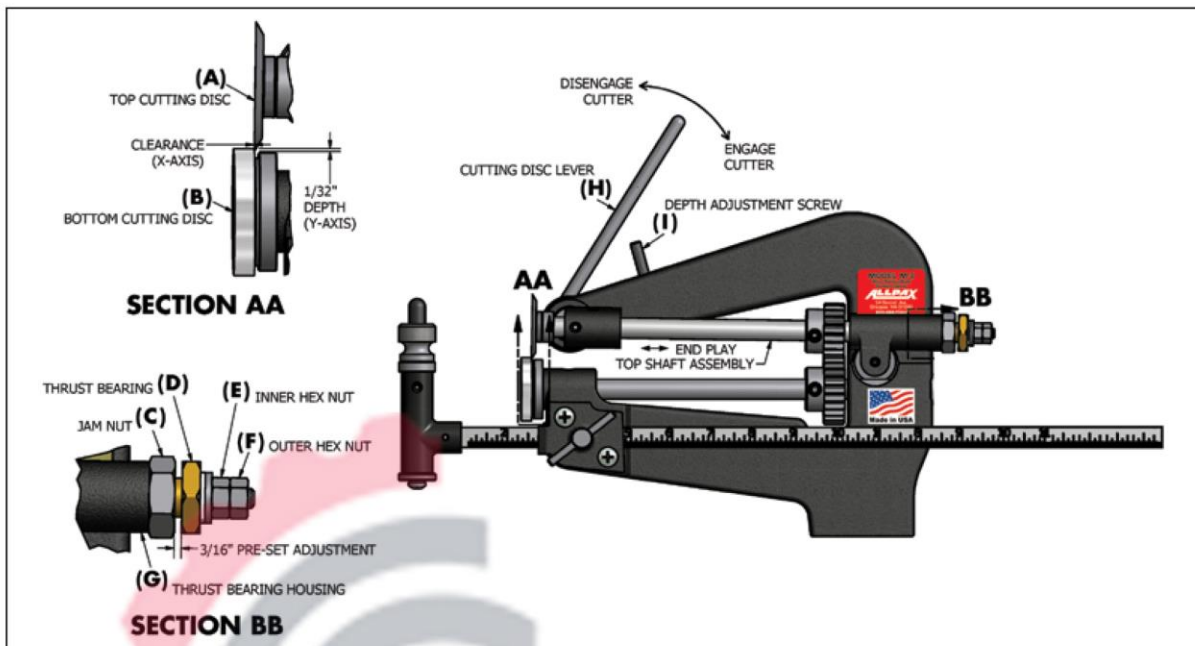

(Figure 15)



















GENERAL MAINTENANCE AND LUBRICATION



(Figure 16) The Motorized M3 is pre-lubricated at the factory. Like any piece of precision machinery, regular cleaning and lubrication of all gears, and moving parts is recommended. Light machine oil should periodically be applied to points 1, 2, 3, 4, 5, 6 and 7. Replace worn parts as necessary.

REPLACEMENT PARTS

MOTORIZED M3 PARTS (AX7200)

PRODUCT	PART #	DESCRIPTION
	AX1400	Top Cutting Disc for Non-Metallic Gaskets
	AX1401	Bottom Cutting Disc for Non-Metallic Gaskets
	AX1402	Cutter Set for Non-Metallic Gaskets
	AX1490	2'- 62" Long Scale Bar
	AX1413	Scale Bar Knurled Nut
	AX1414	Scale Bar Spindle Assembly
	AX1420	Thrust Bearing Housing
	AX1421	Thrust Bearing
	AX1422	Top Shaft Gear
	AX1423	Top Shaft
	AX1424	Bottom Shaft Gear
	AX1491	Bottom Shaft
	AX1492	Top Cutter Lifter Bearing
	AX1427	Top Cutter Lifter Cam
	AX1430	Spanner Wrench
	AX1431	11/32" Hole Punch
	AX1450	Top Shaft Hardware Kit. Contains Teflon Washers (2), Beveled Washers (2), Pan Head Screws (2), Thrust Bearing, Hex Jam Nut, Hex Nuts (2), Flat Washer
	AX1451	Scale Bar Plate Kit. Contains Retaining Plate, Pan Head Screws (2), Center Bar Tee Screw
	AX1452	Scale Bar Spindle Kit. Contains Center Bar Spindle, Center Bar Knurled Nut, Knurled Washer, Pan Head Screw, Helical Lock Washer, Thread, Cap
	AX1493	Chain Assembly
	AX1494	2 Sprockets
	AX1495	Motor

Replacement parts are available from your local distributor or direct from the factory. Visit our website at allpaxcorp.com or call our Customer Service Department for pricing information at 800-482-7324.

ADDITIONAL TOOLS

Also available from Allpax Gasket Cutter Systems



HOLLOW PUNCH TOOL KITS

- Available in Standard (1/8" to 2" OD) and Metric (2mm to 50mm OD) sizes
- Convenient 11, 16 and 27 piece kits



HOLLOW PUNCH TOOLS

- Patented locking system for quick and easy interchange of cutting heads
- Unique design cuts holes (single diameter), or cuts rings (dual diameter) in one operation
- Hardened steel cutting heads stay sharp



ARCH PUNCHES

- High-strength, drop-forged steel
- Available in Standard (3/16" to 2" OD)



POWER PUNCHES

- Available in Standard (1/8" to 2" OD) and Metric (2mm to 50mm OD) sizes
- Convenient 11, 16 and 27 piece kits



DOVE-TAIL PUNCHES

- Perfect for fabricating interlocking dove-tail joints
- Cuts 3/4" to 3" wide flange



DEAD BLOW HAMMERS

- Heavy shot-loaded head reduces rebound & absorbs impact
- Soft face eliminates marring; reduces noise
- Tapered, textured handle ensures superior grip
- Available in 5 sizes; 1 to 3 lbs.



PACKING HOOKS

- Tempered tool steel corkscrew-style bit
- Available in 12 convenient sizes

47 Veterans Drive
Chicopee, MA 01022
Phone (413) 594-4400
Toll Free (800) 482-7324
Fax (413) 594-4884
allpaxcorp.com • info@allpaxcorp.com



تامین و تجهیز ابزار دقیق آرمه
ArmeCompany.com
09125795160



A DIVISION OF
GUARDAIR[®]
CORPORATION